

Legende/ Legend:

BUREAU 250

990 pi.ca.

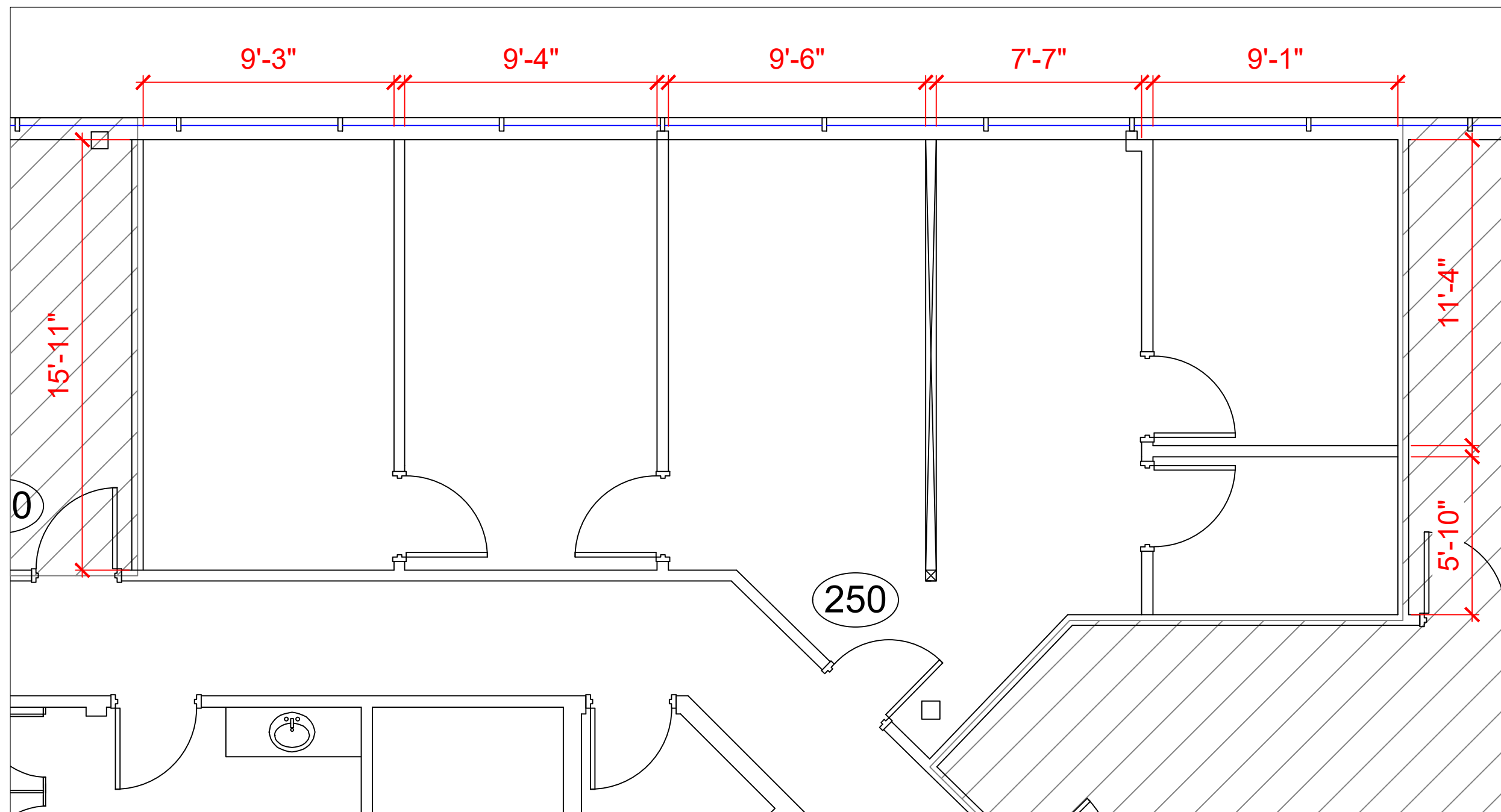

PLAN DU BUREAU

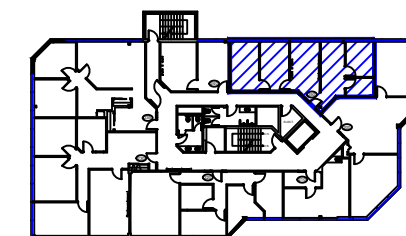

RUE MARION

Plan Clé/
Key Plan

no.	révision/issue	date

Titre/Title : PLAN DU BUREAU
SUITE 250

Echelle/Scale: N.T.S.
 Dessiné par/ Drawn By: R.C.L.
 Date:
 Nom et Localisation du Projet/
 Project Name and Location:
7175 Marion
Trois-Rivières
 Suite/Room #
#250

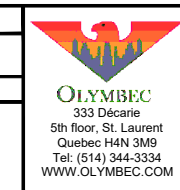

*Veuillez noter que les dimensions indiquées sont approximatives et peuvent changer sans avis/ Note That All Dimensions Are Approximate and subject to change without notice

Q:\CAD Files\Mauricie\Marion 7175 TR\Marion 7175 (Trois-Rivieres).dwg, 2024-01-19 15:16:45, rclavoie, DWG To PDF.pc3

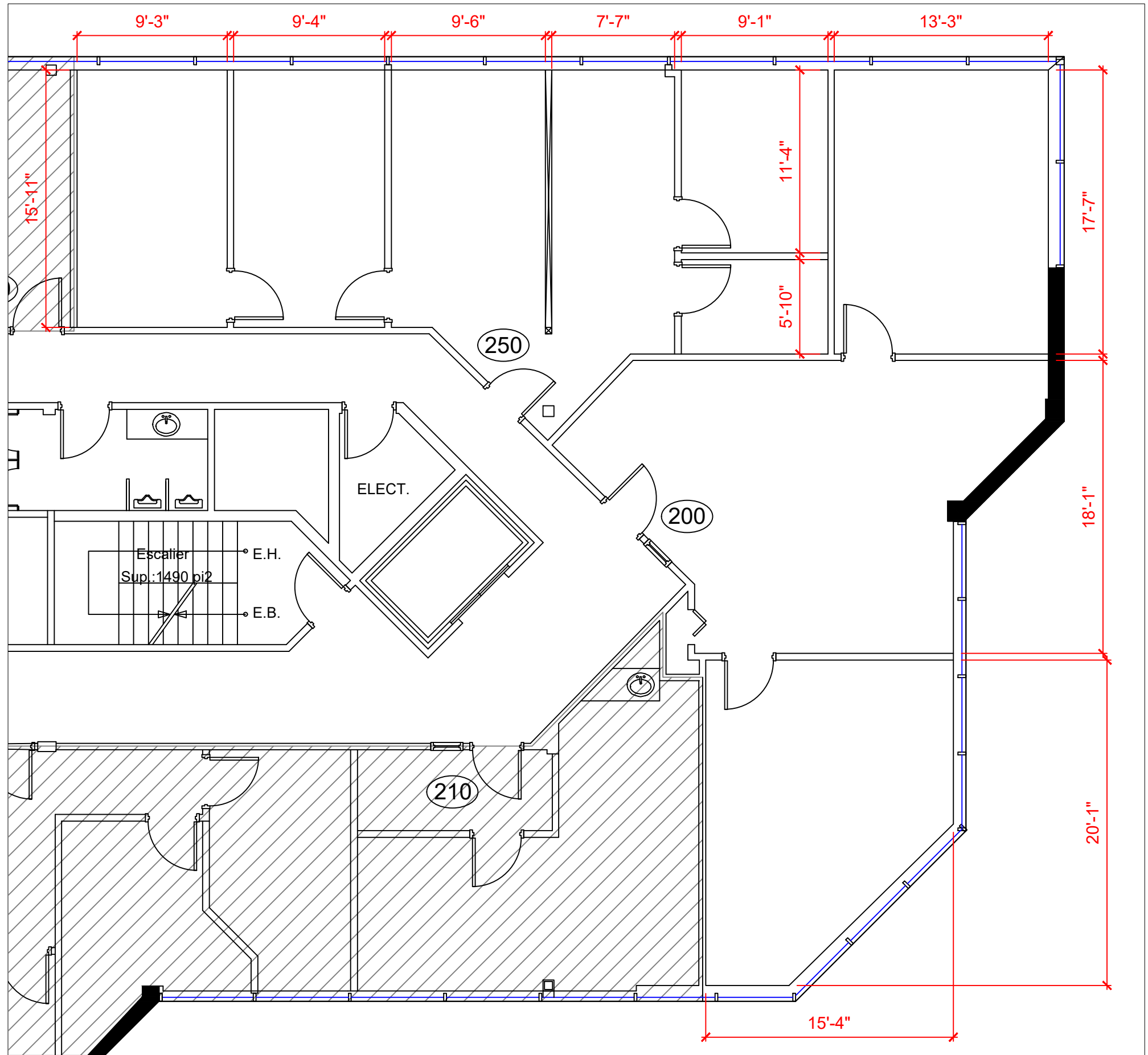

PLAN DU BUREAU

Legende/ Legend:

BUREAU 200-250
2 137 pi.ca.

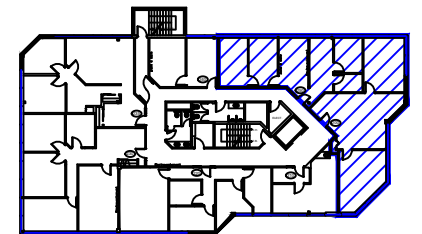

RUE MARION

Plan Clé/
Key Plan

no.	révision/issue	date

Titre/Title : PLAN DU BUREAU
SUITE 200-250

Échelle/Scale: N.T.S.

Dessiné par/ Drawn By:
R.C.L.

Date:

Nom et Localisation du Projet/
Project Name and Location:
7175 Marion
Trois-Rivières

Suite/Room #

#200-250



*Veuillez noter que les dimensions indiquées sont approximatives et peuvent changer sans avis/ Note That All Dimensions Are Approximate and subject to change without notice

Legende/ Legend:

BUREAU 250

990 pi.ca.

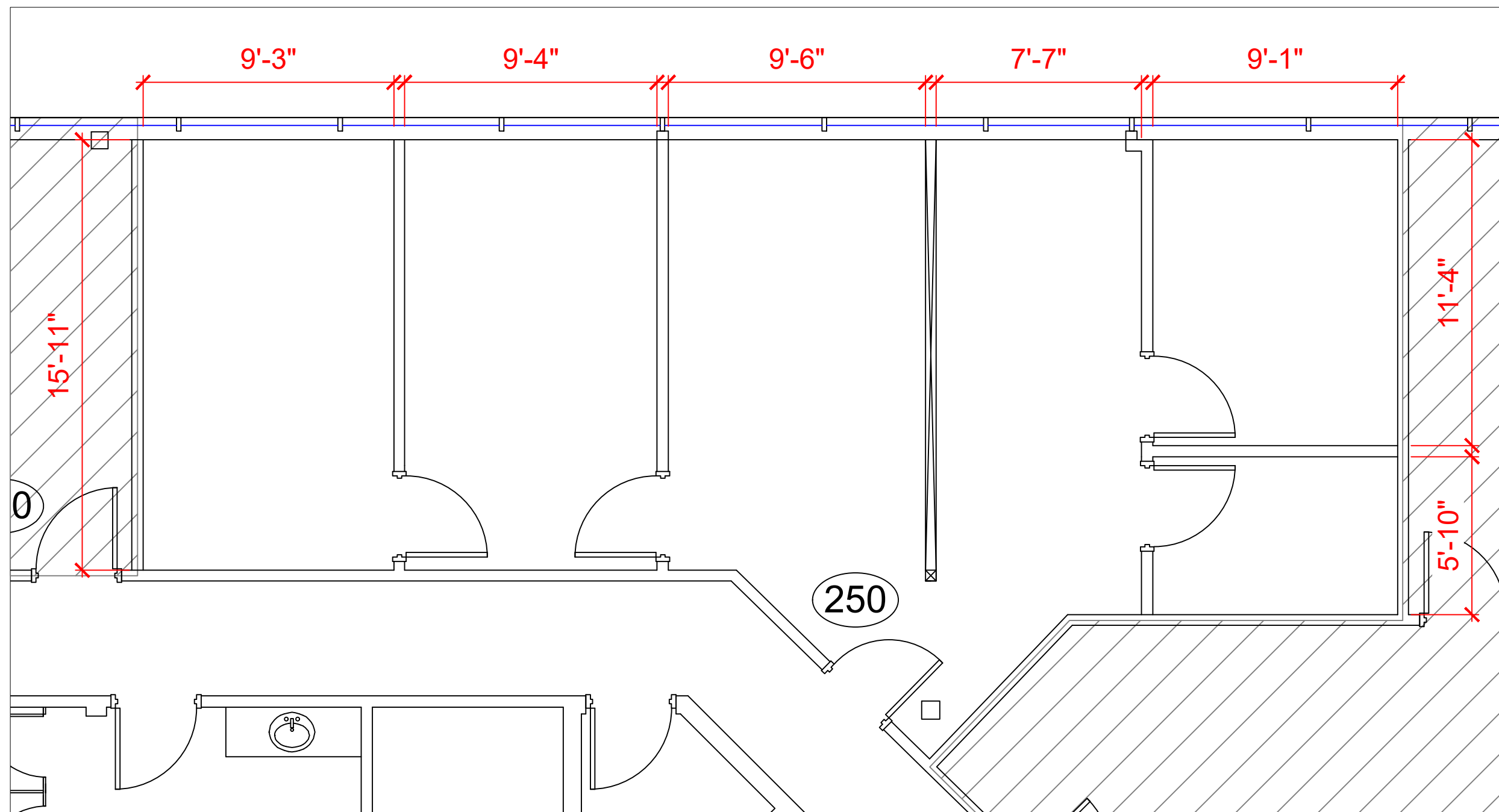

PLAN DU BUREAU

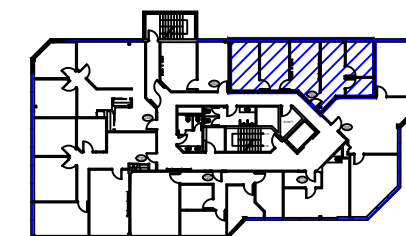

RUE MARION

Plan Clé/
Key Plan

no.	révision/issue	date

Titre/Title : PLAN DU BUREAU
SUITE 250

Echelle/Scale: N.T.S.
 Dessiné par/ Drawn By: R.C.L.
 Date:
 Nom et Localisation du Projet/
 Project Name and Location:
7175 Marion
Trois-Rivières
 Suite/Room #
#250

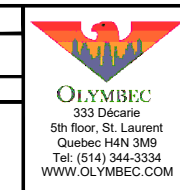

*Veuillez noter que les dimensions indiquées sont approximatives et peuvent changer sans avis/ Note That All Dimensions Are Approximate and subject to change without notice

Q:\CAD Files\Mauricie\Marion 7175 TR\Marion 7175 (Trois-Rivières).dwg, 2024-01-19 15:16:45, rclavoie, DWG To PDF.pc3

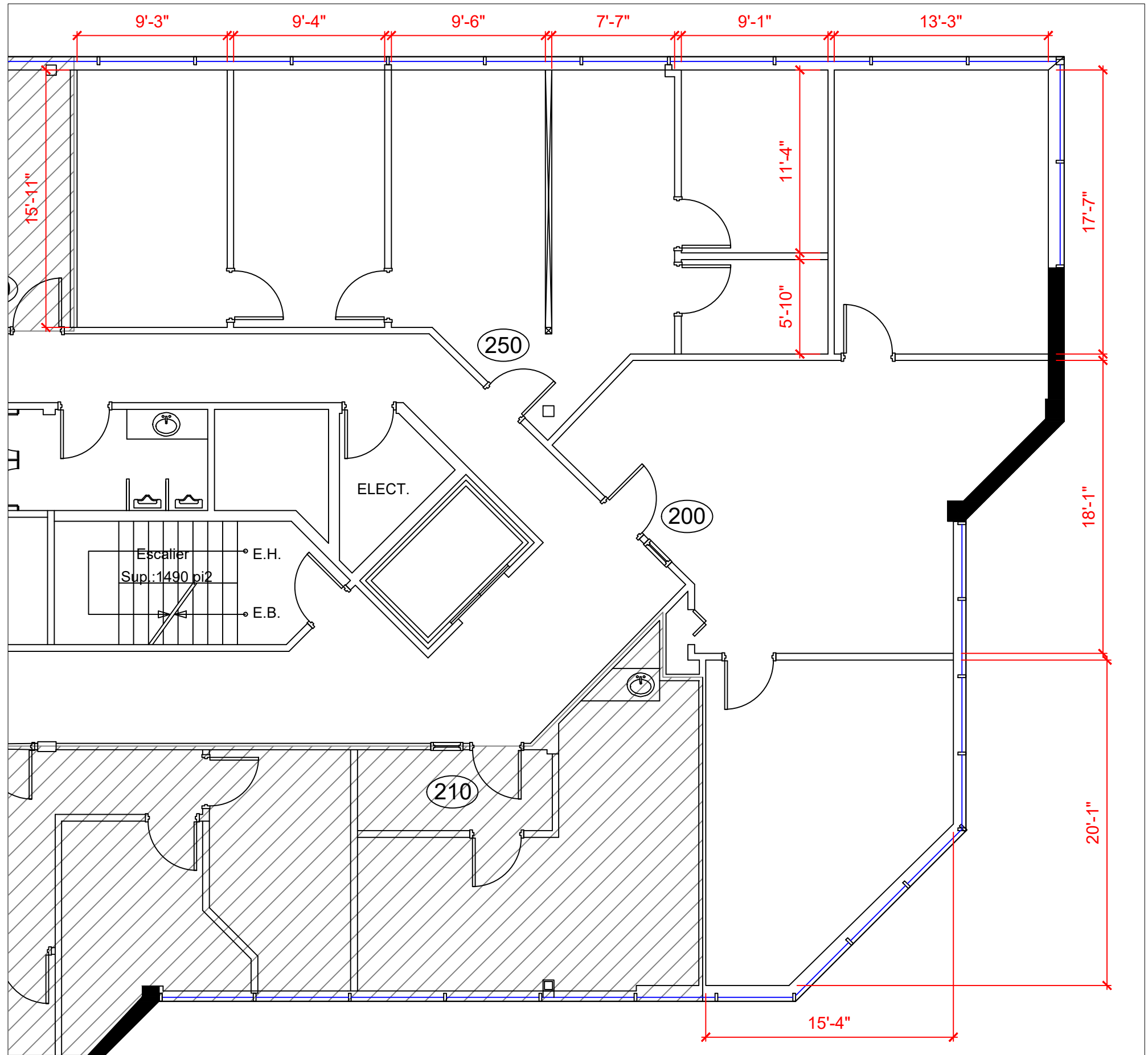

PLAN DU BUREAU

Legende/ Legend:

BUREAU 200-250
2 137 pi.ca.

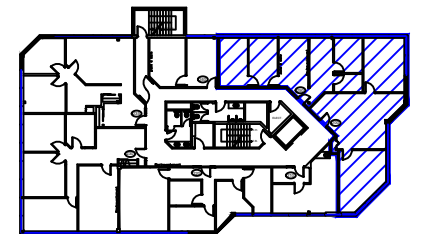

RUE MARION

Plan Clé/
Key Plan

no.	révision/issue	date

Titre/Title : PLAN DU BUREAU
SUITE 200-250

Échelle/Scale: N.T.S.

Dessiné par/ Drawn By:
R.C.L.

Date:

Nom et Localisation du Projet/
Project Name and Location:
7175 Marion
Trois-Rivières



Suite/Room #

#200-250

*Veuillez noter que les dimensions indiquées sont approximatives et peuvent changer sans avis/ Note That All Dimensions Are Approximate and subject to change without notice

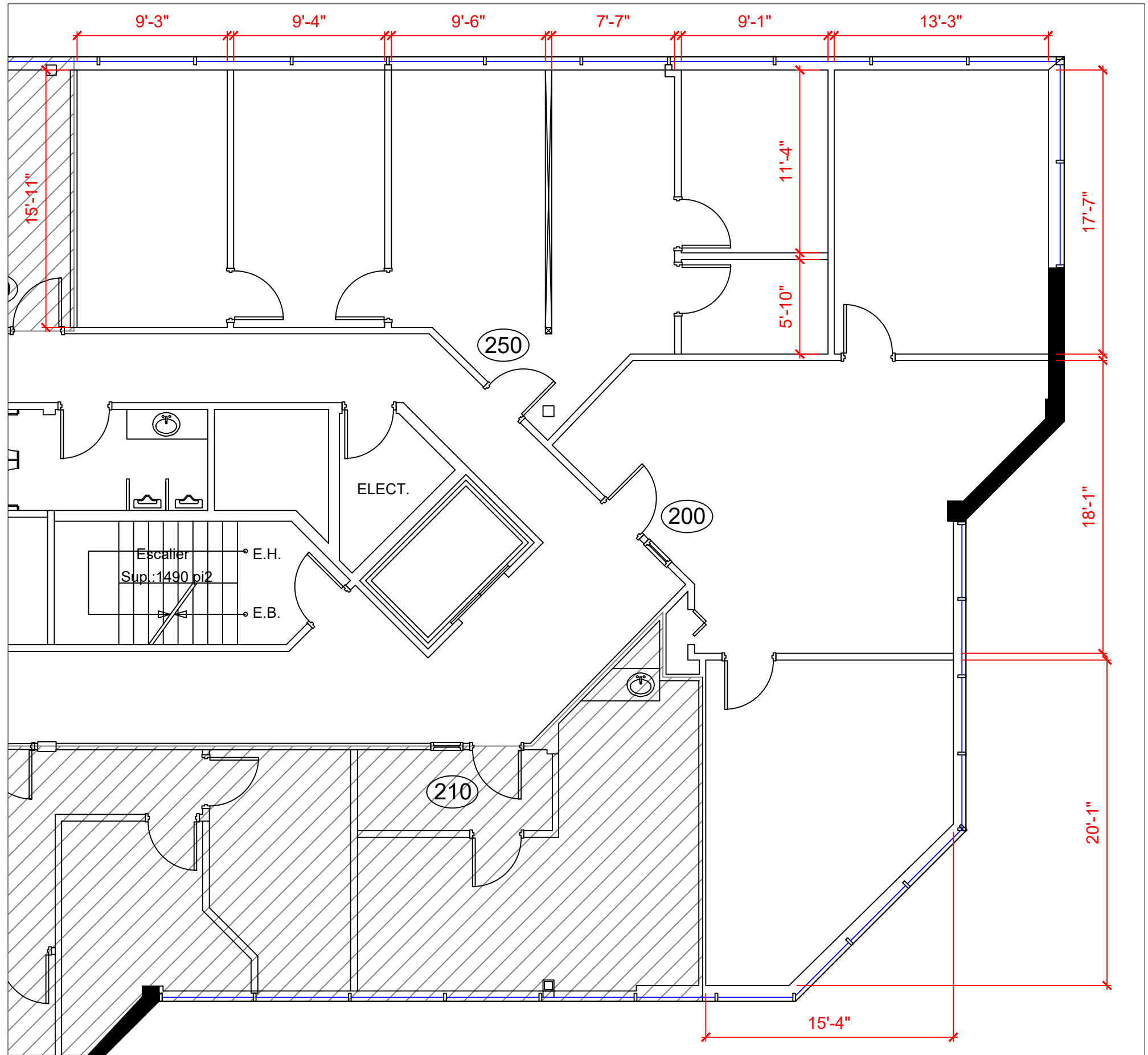

PLAN DU BUREAU

Legende/ Legend:

BUREAU 200-250
2 137 pi.ca.

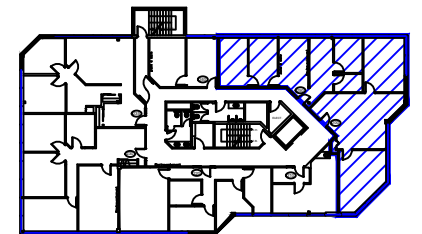

RUE MARION

Plan Clé/
Key Plan

no.	révision/issue	date

Titre/Title : PLAN DU BUREAU
SUITE 200-250

Échelle/Scale: N.T.S.

Dessiné par/ Drawn By:
R.C.L.

Date:

Nom et Localisation du Projet/
Project Name and Location:
7175 Marion
Trois-Rivières

Suite/Room #

#200-250



*Veuillez noter que les dimensions indiquées sont approximatives et peuvent changer sans avis/ Note That All Dimensions Are Approximate and subject to change without notice

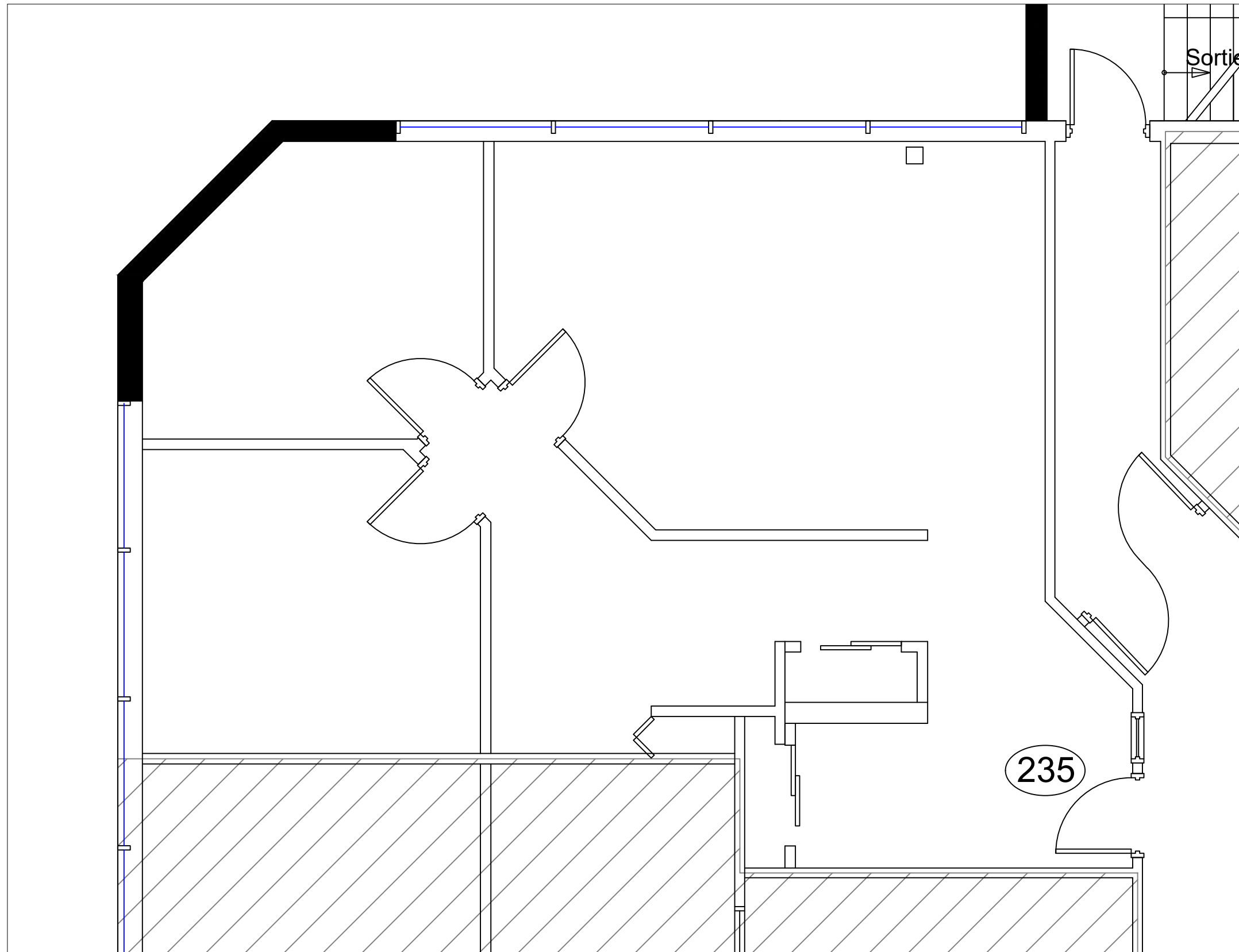

PLAN DU BUREAU

Legende/ Legend:

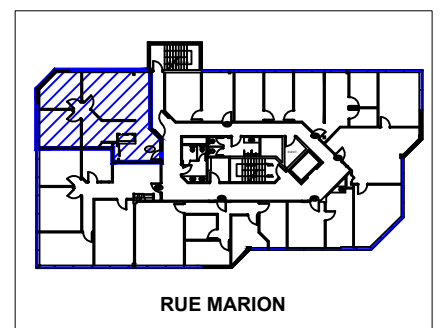

RUE MARION
Plan Clé/
Key Plan

no.	révision/issue	date

Titre/Title: **PLAN DU BUREAU
SUITE 235**

Échelle/Scale: N.T.S.
 Dessiné par/ Drawn By:
 R.C.L.
 Date:
 Nom et Localisation du Projet/
 Project Name and Location:
**7175 Marion
Trois-Rivières**



OLYMBEC
 333 Décarie
 5th floor, St. Laurent
 Quebec H4N 3M9
 Tel: (514) 344-3334
 WWW.OLYMBEC.COM

Suite/Room #
#235

*Veuillez noter que les dimensions indiquées sont approximatives et peuvent changer sans avis/ Note That All Dimensions Are Approximate and subject to change without notice